

RWD

RWD Life Science Co.,Ltd

MP-500

Micropipette Puller

User Manual

A

© 2021 RWD Life Science Co., Ltd. All Rights Reserved.

## INTELLECTUAL PROPERTY RIGHT

The intellectual property rights of this product and its user manual are owned by RWD Life Science Co., Ltd. (hereinafter referred to as RWD), including but not limited to patents, trademark rights, and copyrights.

RWD reserves the right of final interpretation of this user manual.

RWD has the right to treat this user manual as confidential. Without the written permission of RWD, no individual or organization should disclose this user manual, in whole or in part, by any means, nor allow others or organizations to access the information of this user manual, in whole or in part, by any means.

Without the written permission of RWD, no individual or organization should publish, modify, copy, distribute, rent, adapt or translate this user manual into other languages, in whole or in part.

**RWD**

is the registered trademark or trademark of RWD. The trademark and related security marks are intangible properties owned by RWD. The use of trademarks or marks not owned by RWD in this user manual is for no other purposes except for editing, and the rights to them belong to their respective owners.

## STATEMENT

RWD reserves the right to modify this manual without prior notice.

RWD reserves the right to make changes in technology without prior notice.

RWD reserves the right to modify product specifications without prior notice.

RWD provides no guarantee in any form for this manual, including (but not limited to) the implied warranty of merchantability and fitness for a particular purpose.

RWD considers itself responsible for the safety, reliability and performance of the device only if:

The assembly operations, expansion, readjustment, improvement and repair of this product are performed by professionals approved by RWD;

The relevant electrical devices conform to the national standards;

The device is used by following the operating instructions.

RWD assumes no liability for the safety, reliability and performance of the product if:

The components are disassembled, stretched or re-debugged;

The device is repaired or modified by an unauthorized person of RWD;

The product fails to be used correctly according to the user manual.

# Content

<b>1-Introduction.....</b>	<b>1</b>
1.1 Overview.....	1
1.2 Safety .....	1
1.3 Product introduction.....	1
1.4 Product Features.....	2
1.5 Product Parameters .....	3
1.6 Accessories.....	4
1.7 Device Conditions .....	4
<b>2-Important information and security .....</b>	<b>5</b>
2.1 Labels.....	5
2.2 Safety Cautions .....	5
2.2.1 General safety.....	5
2.2.2 Safety Instructions.....	5
2.3-Safety Function .....	6
<b>3-Product interface and buttons .....</b>	<b>7</b>
<b>4-Operating Procedures.....</b>	<b>8</b>
4.1 Initial start .....	8
4.2 Install glass.....	10
4.3 Softening point Test .....	11
4.4 Edit Parameters.....	13
4.5 Pull Protocol .....	13
4.6 Start and pause .....	15
4.7 Program List.....	15
4.8 Remove microelectrode .....	16
4.9 Pull results.....	16
4.10 Preheat jaws .....	17
4.11 Parameter adjustment.....	18
4.12 System Setting .....	22
4.12.1 System diagnosis.....	23

4.12.2 Help .....	25
4.12.3 System Maintenance.....	27
<b>5-Troubleshooting.....</b>	<b>29</b>
<b>6-Maintenance .....</b>	<b>30</b>
6.1 Overview.....	30
6.2 Cleaning and Maintenance.....	30
6.3 Replace filament .....	30
6.4 Replace Drierite canister.....	35
6.5 General check.....	37
6.6 Annual inspection.....	38
<b>7-Warranty.....</b>	<b>39</b>

# 1-Introduction

## 1.1 Overview

---

First of all, thank you for choosing MP-500 Micropipette Puller made by RWD!

Please be sure to carefully read all the information attached before installing and using this product for the first time, which will help you use the product better.

RWD Life Science Co., Ltd. is committed to continuously improving product functions and service quality, and reserves the right to make changes to any product described in this manual and the content of this manual without prior notice.

For the latest product information, please contact us by telephone or mail, or visit our website ([www.rwdstco.com](http://www.rwdstco.com)). Please contact RWD if you find any inconsistency between the actual product and the information contained herein during the use of the device, or when you have any questions or suggestions.

- Model: MP-500 Micropipette Puller

## 1.2 Safety

---

When operating the device, users should read the section **2-Important information and security** to avoid injury to the operator and damage to the device during use.

If you have any questions or suggestions on safety, please contact us for after-sales service support.



The device should be operated and managed by trained professionals!



This device is not intended for medical use. Microelectrodes pulled by this device should be used only for animal experiments in a laboratory environment, but not be applied on human bodies in any form.

## 1.3 Product introduction

---

The Micropipette Puller consists of a heating assembly, a pulley assembly and an air cooling system. It can make a single capillary glass softened by high temperature heating and then pulled into two glass microelectrodes with symmetrical tips. It is mainly used by experimental operators for patch clamp experiments and microinjection operations in the laboratory environment in universities, research institutions, hospitals and assisted reproductive

institutions, or used in various application scenarios that require micro-control operations in industry.

User	Descriptions
Electrophysiology researchers	From scientific research institutions, hospitals, pharmaceutical companies and CROs, engaged in patch clamp and other electrophysiological recording research, using glass microelectrodes filled with electrolyte solution to collect weak bioelectric signals such as ion channel current potential.
Microinjection researchers	From various scientific research institutions and hospitals, engaged in intracellular injection operation research (including embryonic stem cell injection, intracytoplasmic sperm injection, prokaryotic DNA injection, etc.).
Biological researchers	From various scientific research institutions and hospitals, engaged in cell selection, collection, transfer and other micromanipulations.
Application in industry	Preparation of liquid flow pipeline and liquid flow control system in microfluidic chip technology, preparation of nozzles in new printed circuit and 3D printing technology, preparation of operating needles in cell cutting and capture systems, probe production or preparation of particle capture needles in material science.

## 1.4 Product Features

---

- The user interface adopts capacitive color touch screen with high sensitivity.
- The front panel cover adopts a roller design, which is convenient for users to open easily.
- According to the type of capillary glasses and heating filaments and the type of microelectrodes to be pulled (patch clamp microelectrodes, intracellular recording microelectrodes, etc.), the corresponding pull protocol is provided as a reference and can be modified according to special requirements.
- The integrated plug-in humidity control chamber is easy to disassemble. The chamber can keep the air around the filament and the capillary glass dry during the pulling process, which can avoid the adverse effect of humid air on the pulling result.
- The unique fixed position design of the heating filament makes it easier to replace various models of filaments.
- The one-button glass softening point test function is displayed directly on the main interface for customer convenience.

- The mechanical structure specially designed for the capillary glass makes the installation and removal of the glass more convenient and safer.
- The safe heat mode can avoid the damage of the filament from high temperature.
- The preheating and constant temperature function can reduce the influence of the accumulation of jaw heat on the consistency of the pulling results during continuous pulling.
- Two microelectrodes with symmetrical tips are stably produced every time. The diameter of the tip can be less than 0.1 micron, the taper length 3-15 mm, and the impedance range from 1 to above 100 megohm with high repeatability.
- The system diagnostic function can be used to automatically check whether all components of the puller are in normal working condition.
- The copy-and-paste function makes it easier to copy existing programs.
- The device can store up to 99 pulling programs.

## 1.5 Product Parameters

---

Parameters	Description
Display size	7-inch capacitive color touch screen
Display Pixels	1024×600 px
Device Size	530×355×278 mm(length×width×height)
Softening point	1-999
Pressure	1-999
Puff(s)	1-30
Cycles	1-10
Heat	1-999
Pull	0-255
Velocity	1-255
Cooling mode	Time mode (1-255), Delay mode (1-255)

## 1.6 Accessories

Configuration	Name	Quantity	Description
Standard	MP-500 Micropipette Puller	1	Main unit
Standard	Power wire	1	Plug-in power wire for device power input
Standard	Electrode storage box	1	For storing microelectrodes pulled
Standard	Double-end screwdriver	1	To disassemble and assemble accessories. One end is cross and the other slotted.
Optional	HF-3025B、HF-3030B HF-2545B heating filaments	3	For heating capillary glass. Users can choose one for requirements.
Optional	6 kinds of cored glass: B-15086-10F、B-10050-10F、 B-10078-10F、B-12069-10F、 B-12094-10F、B-150110-10F	6 boxes	For pulling microelectrodes. Users can choose according to common models.
Standard	Certificate of Inspection	1	/
Standard	Packing list	1	/
Standard	Easy Adjustment Guide	1	/

## 1.7 Device Conditions

Please prepare the device operating environment under the conditions listed in the table below to ensure the operation and safety of the device.

Environment type	Description
Operating conditions	Temperature: 5-40 °C Recommended laboratory temperature: 20-25 °C
	Humidity: 10%-80% (non-condensing) (10%-80% at 31 °C, 10%-50% at 40 °C) Recommended laboratory humidity: 50%-80%
Storage conditions	Temperature: -20-60 °C
	Humidity: 10%-93% (non-condensing)
	Pressure: 50 kPa-106 kPa
Power	AC power: 100-240 V AC, 50/60 Hz; maximum power 150 W
Others	Avoid direct sunlight and rain; avoid severe vibration; the altitude cannot exceed 2000 m; placed on a level and stable platform



## 2-Important information and security

### 2.1 Labels

---



High temperature warning

Caution! High temperature!

Do not touch the heating filament and jaw with your hands. After pulling, wait for the air pump to finish spraying and then gently pinch the end of the microelectrode to remove it. Take care to avoid the tip of the microelectrode.

### 2.2 Safety Cautions

---

#### 2.2.1 General safety

- Please follow the instructions of all safety warnings and instruction labels on the device and in the manual;
- The device should be operated by trained professionals;
- The device is only allowed to operate within its applicable scope, and only accessories suitable for this device are allowed to be used. RWD shall not be responsible for any device damage caused by any non-conforming operation, including the damage to a third party.

#### 2.2.2 Safety Instructions

- Radio interference For Class A equipment that emits radio interference specified in the EN 61326-1/EN 55011 Standard, this device is designed and tested in accordance with Group 1 Class A in CISPR11.

**Warning!** Class A equipment is used in an industrial environment. Due to the conduction disturbance and radiation disturbance of the equipment during use, it may be difficult to ensure electromagnetic compatibility in other environments.

- The device should be installed in a well-ventilated location, and the distance between the device and the wall is at least 20 cm to ensure that the ventilation is not blocked;
- The device should be kept away from the flammable and explosive locations;
- To prevent the risk of electric shock, the power wire of this device can only be connected to a grounded three-hole socket;
- Do not put anything into the device from the gap, otherwise it may cause a fire or electric shock. Do not spill any liquid on the device;

- To prevent the risk of fire or electric shock, do not expose this device to rain or any type of moisture;
- Do not expose this device to direct sunlight;
- Do not place heavy objects on the device;
- Microelectrodes pulled by this device have sharp tips. **Please do not touch the tips with your hands;**
- Microelectrodes pulled should be placed in the attached electrode storage box to prevent the tip of the microelectrode from collision and damage or to prevent dust particles from entering the microelectrode and blocking the tips;
- The microelectrode should be placed in sharp container and sealing for safety after use.
- Do not disassemble this device. Only after-sales maintenance personnel designated by RWD can disassemble the device or repair accessories.

## 2.3-Safety Function

---

- The device is equipped with a low light transmittance cover covering the entire pulley assembly, which can isolate the hazardous factors that may occur during the pulling process, including the heat of the filament, dazzling light, and the rapid movement of the clamping arm.
- If the heating function is abnormal, the device will automatically turn off the power.

### 3-Product interface and buttons

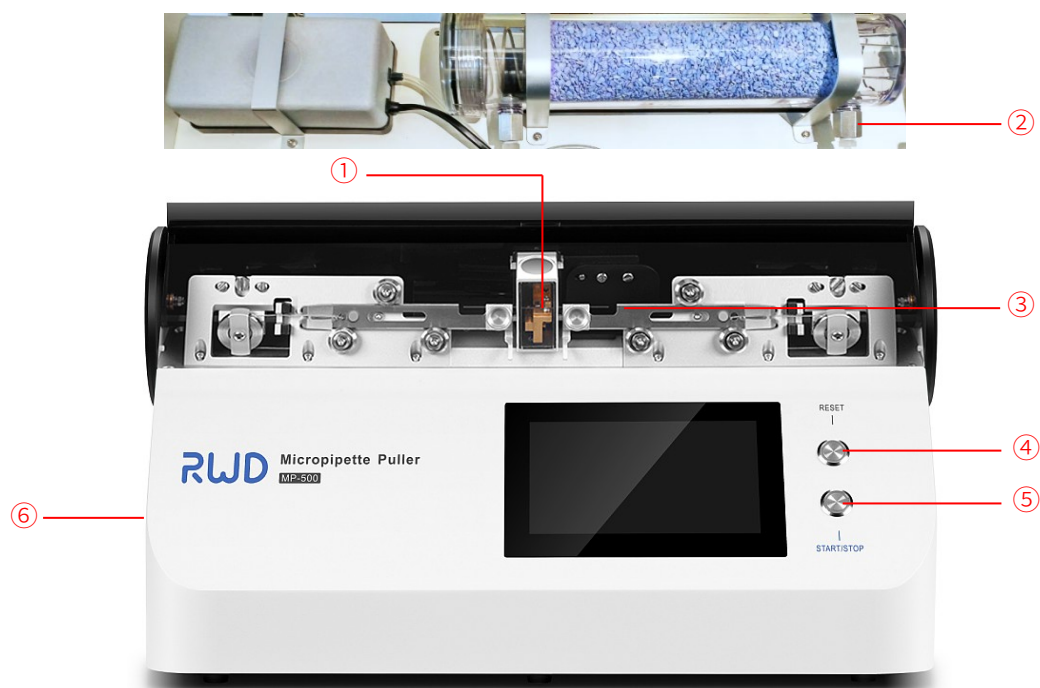

Figure 3-1



Figure 3-2

No.	Components	Quantity	Description
①	Jaw	2	Install the filament
②	Drierite canister interface	2	Connect the Drierite canister
③	Capillary glass mounting brackets	2	Install the capillary glass
④	Red button	1	System restart
⑤	Green button	1	Multi-function button
⑥	Power switch	1	Turn on/off the main power of the device
⑦	Power interface	1	Connect the power wire
⑧	USB port	1	System update interface

# 4-Operating Procedures

## 4.1 Initial start

 This device should be placed on a stable and level platform during use. Do not place on the unstable platform!

Connect the power wire, plug it into the three-hole socket, press the power switch to start the device, and the system first displays the boot interface.



Figure 4-1

Wait 30s for the progress bar to load, enter the [Main Interface], as shown in Figure 4-2.

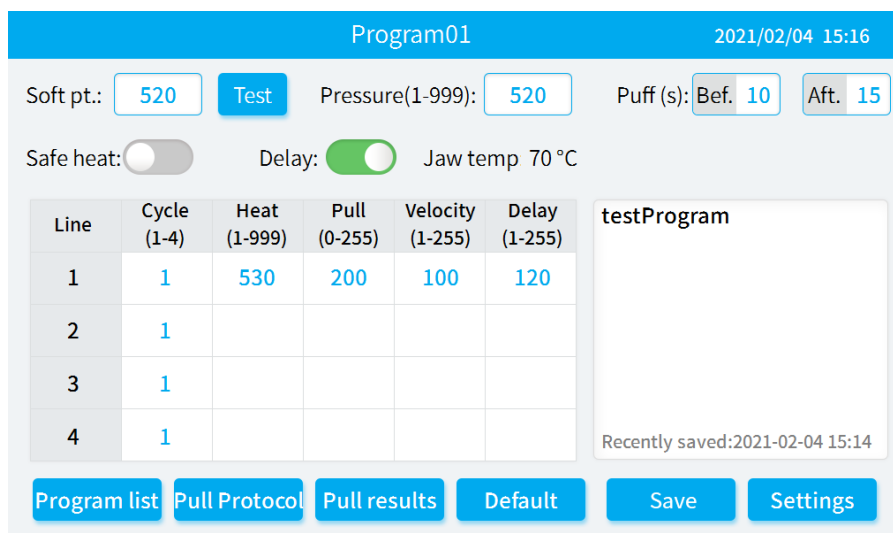

Figure 4-2

Parameters	Description
Softening point	The range of current value causing the filament generating enough heat that can soften the glass is 1-999
Pressure (1-999)	The range of air pressure to cool glass and the heating filament is 1-999
Puff(s)	The reasonable range of duration of the humidity control chamber being filled with dry gas at the beginning and the end of the pulling is 5-20 seconds
Safe heat	In order to avoid unstable pulling or burning the heating filament, the heat cannot be lower or higher than 10% of the softening point
Time	The range of duration of puffing to cool the glass and the heating filament during the pulling of the microelectrode is 1-255
Delay	The range of delay time of heating stop and pulling start is 1-255
Jaw temp	Display the current temperature of the jaw
Cycles	The number of heating cycles. The number of cycles per line ranges from 1 to 10
Heat	The heat range of the heating filament is 1-999
Pull	The pulling force applied to both ends of the glass ranges from 0 to 255
Velocity	The velocity of pulling apart the glass ranges from 1 to 255

## 4.2 Install glass

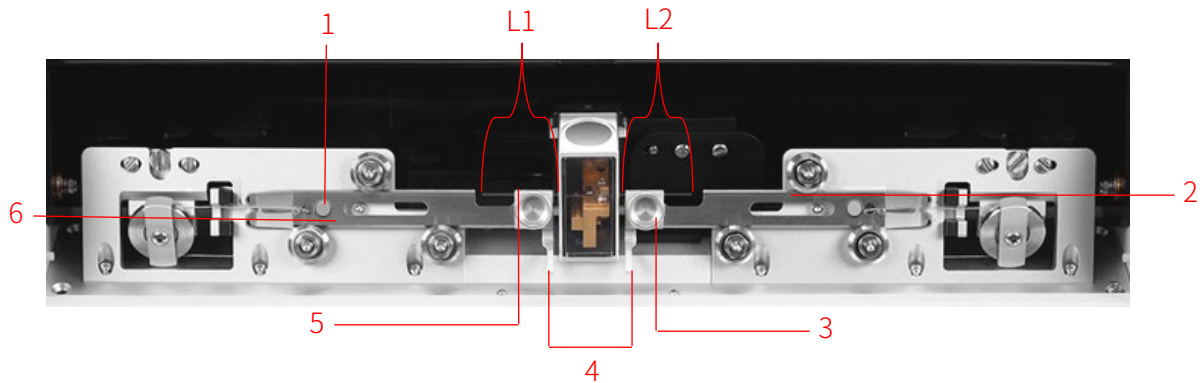

Figure 4-3

No.	Parts
1	button
2	V-groove
3	Clamping knob
4	Puller bar handle
5	Clamping plate
6	Puller bar

- 1) Move the puller bars toward opposite directions to the end of their travels respectively until they are caught to prevent them from sliding left and right;
- 2) First put the glass in the V-groove, turn the knob to fix the glass slightly, and note that the glass can still be slid;
- 3) Press the buttons on both sides to release the puller bars, gently hold the puller bar handles to pull both bars toward each other to the middle of the heating chamber;
- 4) Slightly loosen the knob, gently push the glass along the V-groove and make it carefully go through the heating filament until the lengths of the glass on both bars L1 and L2 are approximately equal; tighten the knob to complete the glass installation.

 **Note!**

The glass must be close to the V-groove when sliding, otherwise the heating filament may be damaged!

 **Note!**

Do not use excessive force when pulling the bars and tightening the knob, otherwise the glass may be broken!

 **Note!**

When the microelectrode used in vivo microinjection, RWD recommends the model of glass is B-15086-10F、B-10078-10F、B-12069-10F、B-150110-10F;

When the microelectrode used in patch clamp, RWD recommends the model of glass is B-15086-10F、B-12069-10F、B-150110-10F、B-12094-10F!

### 4.3 Softening point Test

---

The heating assembly of this device increase the temperature of the heating filament via the current to soften the glass. The softening point is the appropriate current value that can soften the glass. Different types of heating filaments and glass vary in softening points. The device is equipped with 3 types of heating filaments and 6 types of glass. Once the heating filament or different types of glass are replaced, it is necessary to test the softening point and record it.

 **Note!**

Once the heating filament or different types of glass are replaced, a softening point test is required!

When the microelectrode used in vivo microinjection, RWD recommends the model of heating filaments is HF-2545B!

- 1) Click on the [Main Interface] as shown in Figure 4-2 to enter the [Softening point test] interface, as shown in Figure 4-4.



Figure 4-4

- 2) Press the green light button [START] on the right side of the display to start the test.



Figure 4-5

- 3) Get and record the softening point test value.

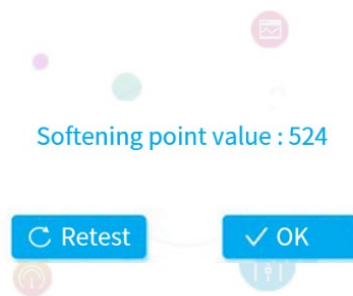

Figure 4-6

- 4) Click **Retest** on the interface in Figure 4-6 to enter the [Softening point test] interface as shown in Figure 4-4 and retest the softening point.
- 5) Click **OK** to enter the [Main Interface] shown in Figure 4-2, and the current softening point test value will be automatically filled in the softening point input box.
- 6) It is recommended to repeat the test 3 times. The maximum value is the softening point.

 **Note!**

After testing softening point, the glass will be broken. Please replace the glass before pulling! Refer to **4.2 Install glass**.



## 4.4 Edit Parameters

In the interface shown in Figure 4-7, each parameter can be edited.

Program01 2021/02/04 15:18

Soft pt.:   Pressure(1-999):  Puff (s): Bef.  Aft.

Safe heat:  Delay:  Jaw temp 70 °C

Line	Cycle (1-4)	Heat (1-999)	Pull (0-255)	Velocity (1-255)	Delay (1-255)
1	1	530	200	100	120
2	1				
3	1				
4	1				

1 2 3 +  
4 5 6 -  
7 8 9   
0 Cancel OK

Figure 4-7

## 4.5 Pull Protocol

In the [Main Interface], click  to select the preset protocols of RWD for pulling.

- 1) Select the heating filament model. Heating filaments are all box-shaped. When the microelectrode used in vivo microinjection, RWD recommends the HF-2545B filament.

Model	Specification(box length×width)
HF-3025B	3.0×2.5 mm
HF-3030B	3.0×3.0 mm
HF-2545B	2.5×4.5 mm

Back Pull Protocol 2021/02/04 15:18

Select heating filament:

3.0×2.5mm box  3.0×3.0mm box

2.5×4.5mm box

Figure 4-8

2) Select capillary glass.

Model	Specification(O.D.×I.D.×length)
B-15086-10F	1.5×0.86×100 mm
B-10050-10F	1.0×0.5×100 mm
B-10078-10F	1.0×0.78×100 mm
B-12069-10F	1.2×0.69×100 mm
B-12094-10F	1.2×0.94×100 mm
B-150110-10F	1.5×1.1×100 mm

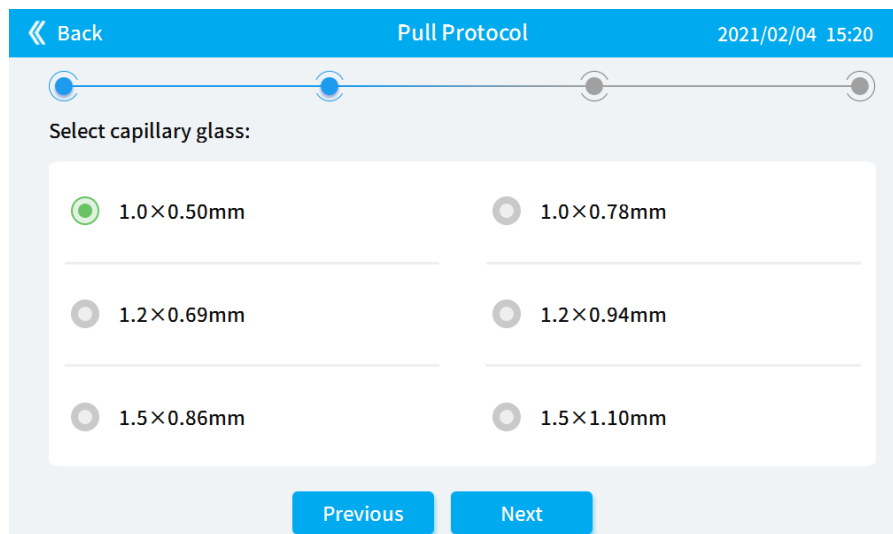

Figure 4-9

3) Select the application of microelectrodes.

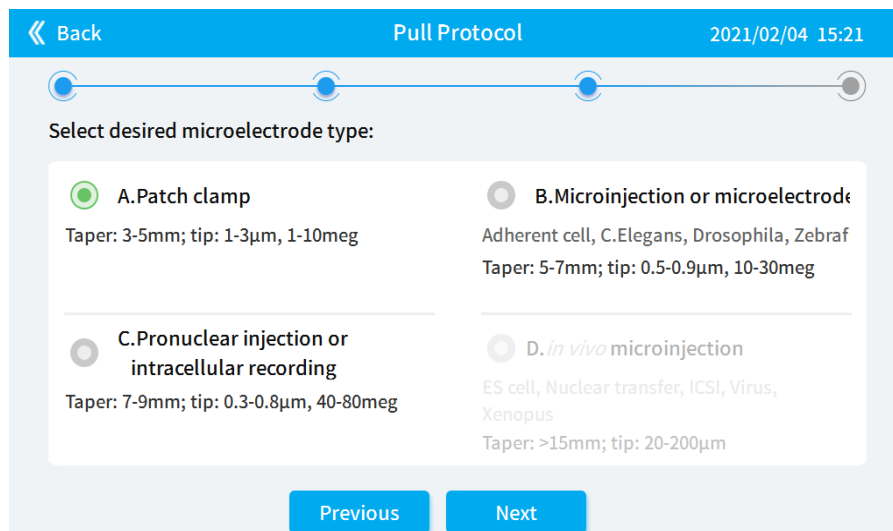

Figure 4-10

4) Finally, the system generates program parameters based on the above three options, and the current protocol can be used as a new program or overwrite current parameters.

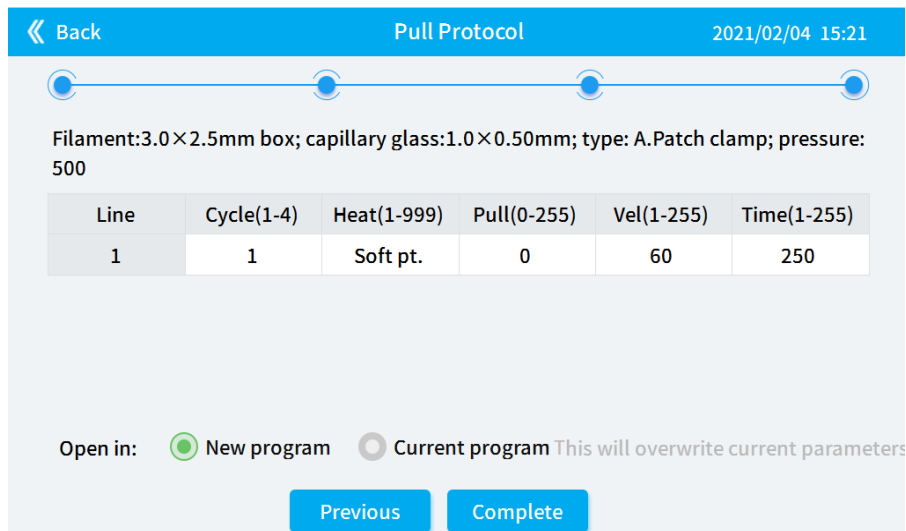

Figure 4-11

## 4.6 Start and pause

The green button [START/STOP] is a multi-function button, which can start or pause pulling; the red button [RESET] can restart the system.

## 4.7 Program List

Click **Save** in the [Main Interface] as shown in Figure 4-2 to save the softening point value and all current parameters.

Click **Program list** on the [Main Interface] to view all saved programs. Up to 99 items can be saved.

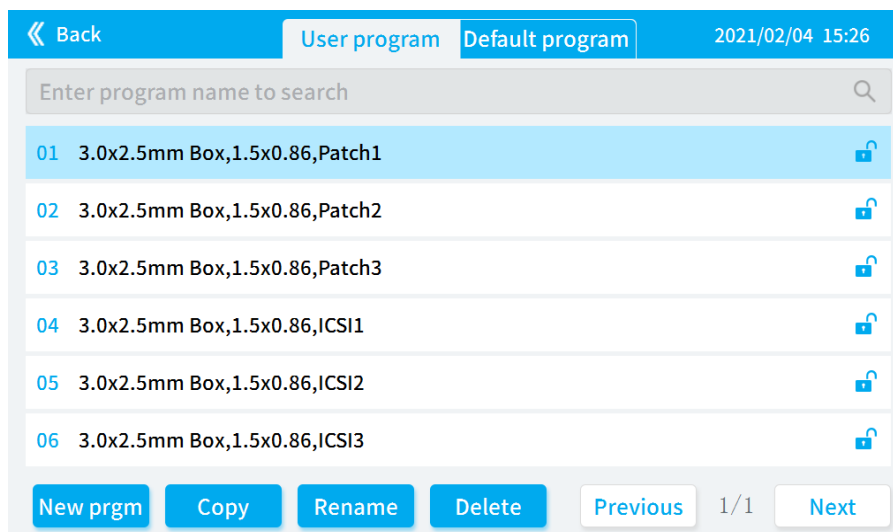

Figure 4-12

Double Click the selected program to open the program;



## 4.10 Preheat jaws

---

The jaw preheating function can improve the stability of the pulled microelectrode. When the ambient temperature is too low (lower than 10 °C) or the ambient temperature changes greater than 10 °C, click **Settings** on the [Main Interface] as shown in Figure 4-2 to turn on the “Preheat jaws to 70°C” function, as shown in Figure 4-14.

If a narrow fluctuation range of the microelectrode impedance is required, it is recommended to turn on the preheating function.

 **Warning!**

Turning on the preheating function will accelerate the consumption of the heating filaments!

When **Jaw temp: 70 °C (Preheating accomplished)** is shown on the [Main Interface] as shown in Figure 4-2, press the green [START] button to start pulling.

 **Warning!**

Test the softening point before turning on the jaw preheating function, otherwise the preheating time may be overlong or the heating filament may be burned!

Turn on the "Preheat jaws to 70°C" function. It may be necessary to adjust the recommended parameters to obtain the target microelectrode. Refer to **4.11 Parameter adjustment**.

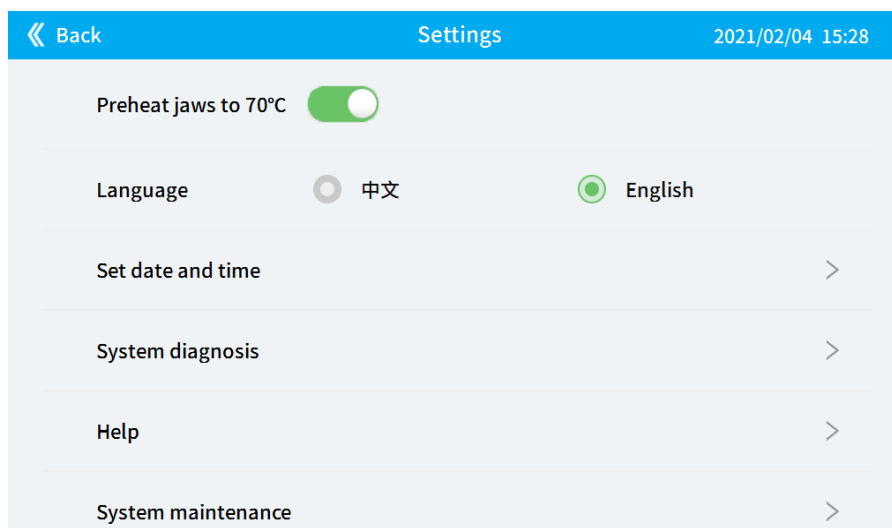

Figure 4-14

## 4.11 Parameter adjustment

After pulling the microelectrode, compare it with the target microelectrode, and adjust the recommended parameters to pull the microelectrode that meets the needs.

### 1. Patch clamp microelectrode adjustment

Select the models of the heating filament and the glass in the [Pull Protocol] interface, select [Patch clamp] to get the recommended parameters, and adjust the parameters according to the following steps.

- Thickwall glass (Model: B-15086-10F, B-12069-10F)

The microelectrode pulled by a thickwall glass is shown in Figure 4-15.

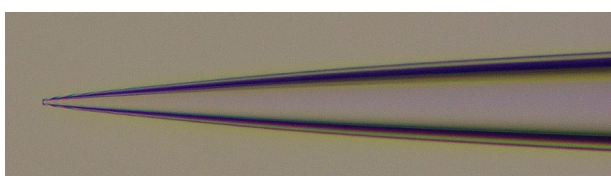

Figure 4-15



#### Note!

When using a thickwall glass to pull a patch clamp microelectrode, set [Delay] to 1, and do not increase or decrease [Delay] parameter!

#### 1) Test median velocity

Based on the recommended parameters, increasing or decreasing the velocity value will get different cycle value. Find the velocity range for 4 cycles and 5 cycles, from which the corresponding median velocity can be calculated.

Example: The recommended velocity is 31, increase or decrease the velocity value, and find the velocity range for 5 cycles is 25-35; the velocity range for 4 cycles is 36-44. Then the median velocity for 5 cycles is  $(25+35) \times 0.5=30$ , and the median velocity for 4 cycles is  $(36+44) \times 0.5=40$ .



When testing the median velocity, the recommended cycles are 4 and 5!

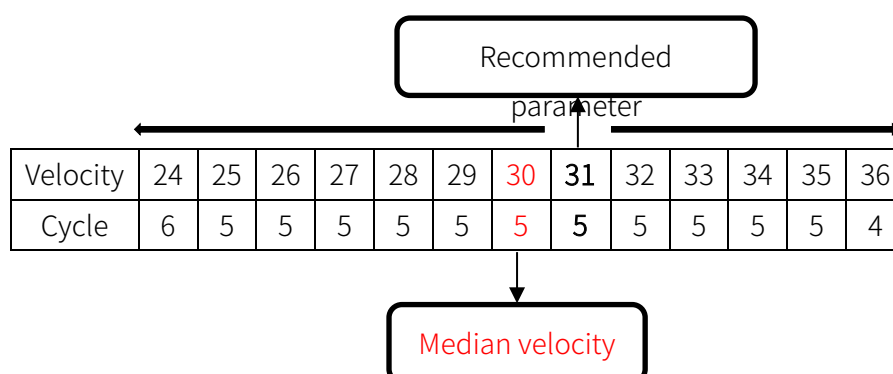

2) Select velocity

Test the impedance corresponding to the median velocity of 4 cycles and 5 cycles, and compares it with the target impedance, and selects the median velocity which the impedance is closer to the target impedance for adjustment.

The impedance values in this manual are obtained when both the internal and external fluid of the microelectrode are Ringer's solutions.

Example: the impedance corresponding to the median velocity of 30 for 5 cycles is 2M, and the impedance corresponding to the median velocity of 40 for 4 cycles is 6M, while the target impedance is  $3 \pm 1M$ ; the impedance corresponding to the median velocity for 5 cycles is more close to the target impedance, so select velocity 30; if the target impedance is 5M, select velocity 40.

3) Adjust parameters based on the selected velocity



**Note!**

The cycle value should remain unchanged during parameter adjustment.

➤ Single-line adjustment method

Adjust the velocity or heat until the microelectrode pulled meets the needs. The velocity adjustment range is  $\pm 10$ , and the heat adjustment range is  $\pm 30$ . Heat should be adjusted first.

Line	Cycle (1-4)	Heat (1-999)	Pull (0-255)	Velocity (1-255)	Delay (1-255)
1	1	520	0	30	1
2	1				
3	1				
4	1				

Figure 4-16

➤ Multi-line adjustment method

Use multi-line adjustment method if the target microelectrode cannot be pulled by the single-line adjustment or the cycle value changes after the single-line adjustment. The heat adjustment range is  $\pm 30$ , and the velocity adjustment range is  $\pm 10$ .

Example: Select the velocity of 30 to cycle for 5 times, divide the setting parameters into 5 lines, and then adjust the heat or velocity of last 1-3 lines to obtain the parameters of the target microelectrode.

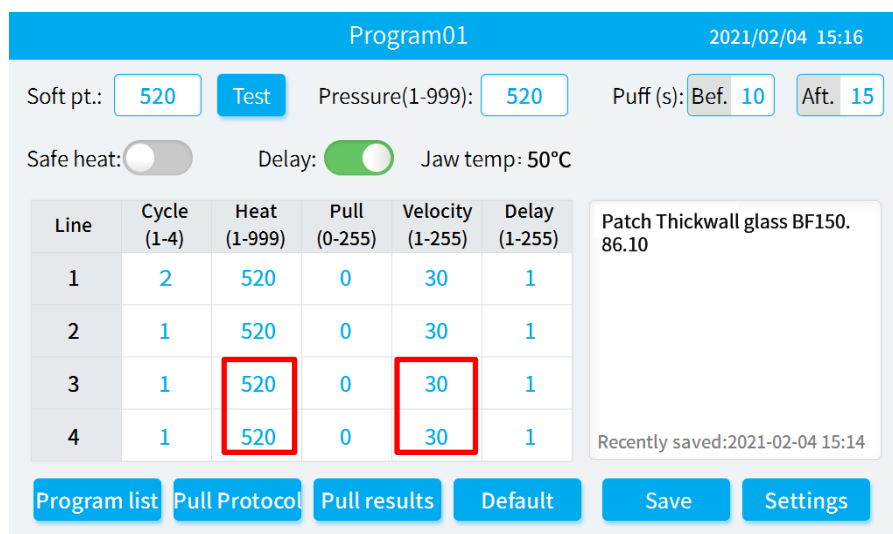

Figure 4-17

- Thinwall glass (Model: B-150110-10F, B-12094-10F)

The microelectrode pulled by a thinwall glass is shown in Figure 4-18.

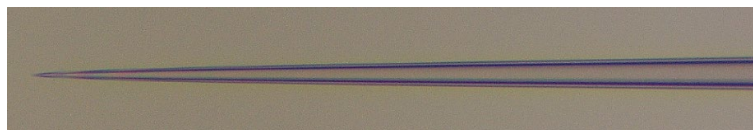

Figure 4-18

Adjust the velocity parameter on the basis of the recommended parameters. The adjustment rules are shown in following table.

## 2. Other microelectrodes adjustment

Adjust the pull or velocity parameter based on the recommended parameters, and the velocity parameter should be adjusted first; if the microelectrode pulled is greatly different from the target microelectrode, the pull and velocity parameters can be adjusted simultaneously.



Heat	5 units change	increase	The tip of the microelectrode becomes smaller, the taper gets longer, and the impedance becomes larger
		decrease	The tip of the microelectrode becomes larger, the taper gets shorter, and the impedance becomes smaller
Pull	10 units change	increase	The tip of the microelectrode becomes smaller, the taper gets longer, and the impedance becomes larger
		decrease	The tip of the microelectrode becomes larger, the taper gets shorter, and the impedance becomes smaller
Velocity	Patch jaw microelectrodes: 1-5 units change; Other microelectrodes: 5-10 units change	increase	The tip of the microelectrode becomes smaller, the taper gets longer, and the impedance becomes larger
		decrease	The tip of the microelectrode becomes larger, the taper gets shorter, and the impedance becomes smaller
Time	10 units change	increase	The tip of the microelectrode becomes larger, the taper gets shorter, and the impedance becomes smaller
		decrease	The tip of the microelectrode becomes smaller, the taper gets longer, and the impedance becomes larger
Delay	10 units change	increase	The tip of the microelectrode becomes larger, the taper gets shorter, and the impedance becomes smaller
		decrease	The tip of the microelectrode becomes smaller, the taper gets longer, and the impedance becomes larger
Pressure	100 units change	increase	The tip of the microelectrode becomes smaller, the taper gets longer, and the impedance becomes larger
		decrease	The tip of the microelectrode becomes larger, the taper gets shorter, and the impedance becomes smaller



**Note!**

Pulling the microelectrode under the critical parameter with the cycle value changing will cause unstable pull results, and above rules may not apply!

## 4.12 System Setting

Click **Settings** on the [Main Interface] as shown in Figure 4-2 to enter the [Setting] interface.

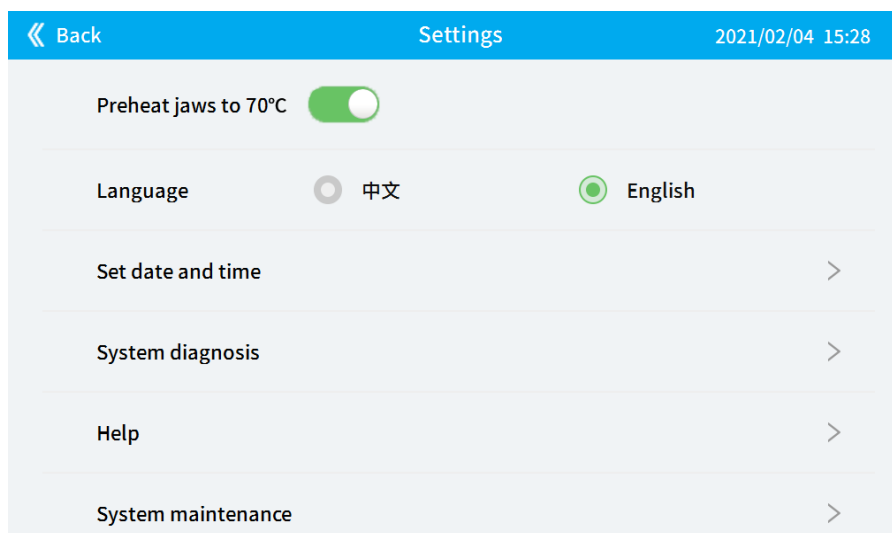

Figure 4-17

Settings	Description
Preheat jaws to 70°C.	Turn on the “Preheat jaws to 70°C” function, referring to <b>4.10 Preheat jaws</b> .
Language	Select the language as Chinese or English.
Set date and time	Set system date and time.
System diagnosis	Diagnostic system, including pressure, heat, pull, and velocity diagnosis.
Help	Including about this puller, track leakage, install filament, install glass, and preheat jaws.
System maintenance	For adjusting screen brightness and for system maintenance by after-sales personnel.

## 4.12.1 System diagnosis

### 1) Pressure diagnosis

Pressure diagnosis is to check whether the air pump runs, whether the air valve is normally opened and closed, and whether there is air leakage.

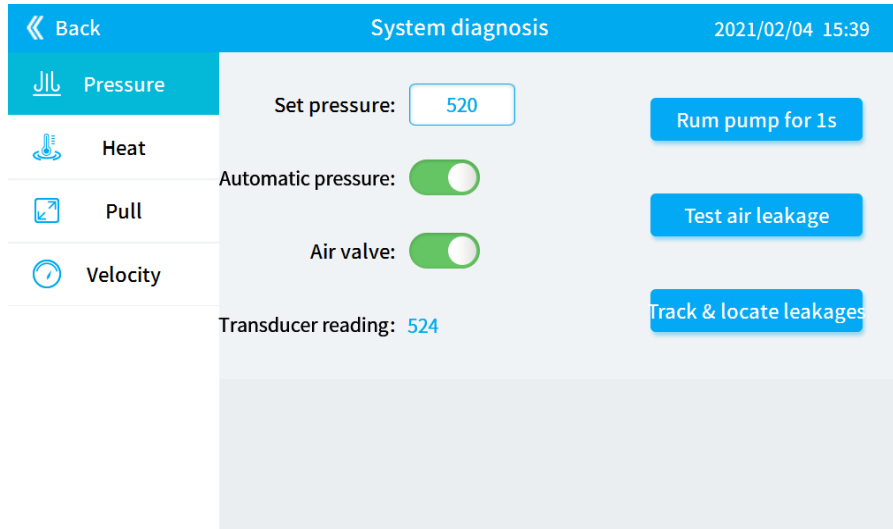

Figure 4-18

Set pressure, the value range is 1-999, turn on [Automatic pressure], the air circuit will automatically run to the set pressure; Turn on [Air valve] to turn on the switch of the jet air valve.

Click **Run pump for 1s** to check if the air pump runs;

Click **Test air leakage**, the system will run an automatic diagnostic program to check whether there is air leakage;

If there is air leakage, click **Track & locate leakages** to enter the interface as shown in Figure 4-19, and follow the prompts on the interface to locate leakages.



Figure 4-19

## 2) Heat diagnosis

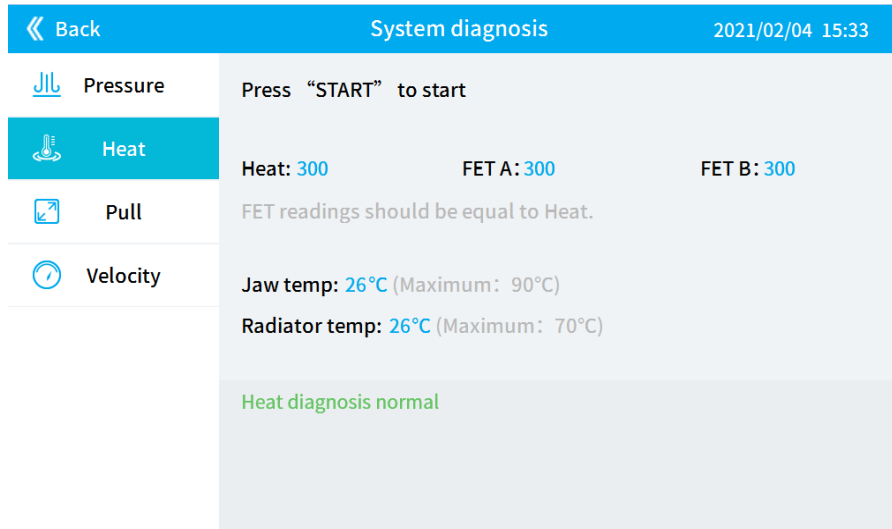

Figure 4-20

## 3) Pull diagnosis

Set the pull value within the value range of 0-255, pull the puller bar handles to the middle, and press the green [START] button on the right side of the display. Set the pull value to correspond to the pull during pulling, and the user can judge whether the pull diagnosis is normal.

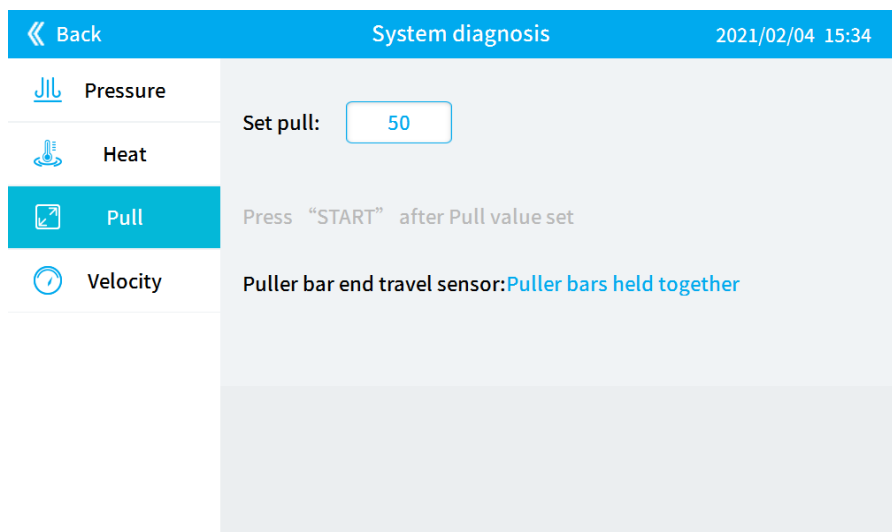

Figure 4-21

## 4) Velocity diagnosis

Set the velocity value within the range of 1-255, then move the puller bars left and right, and when it displays "tripped", it means the velocity diagnosis is normal.

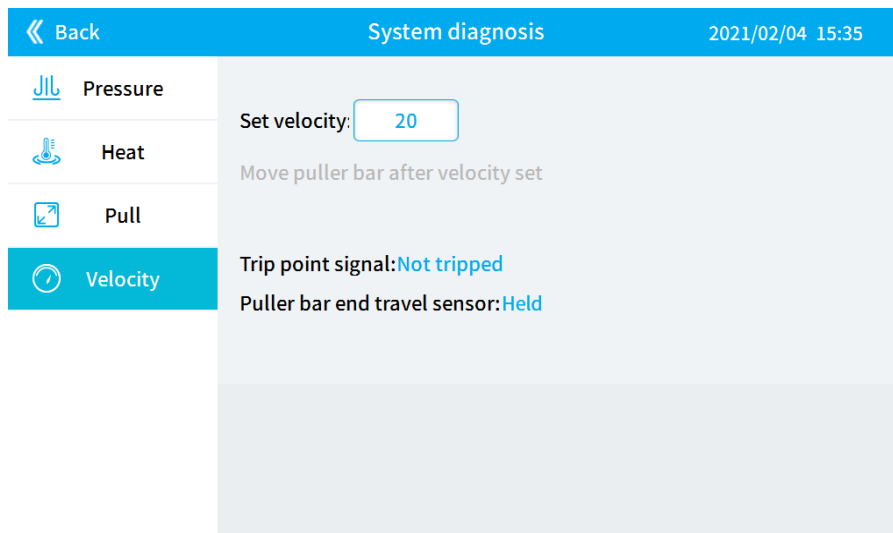

Figure 4-22

## 4.12.2 Help

### 1) About this puller

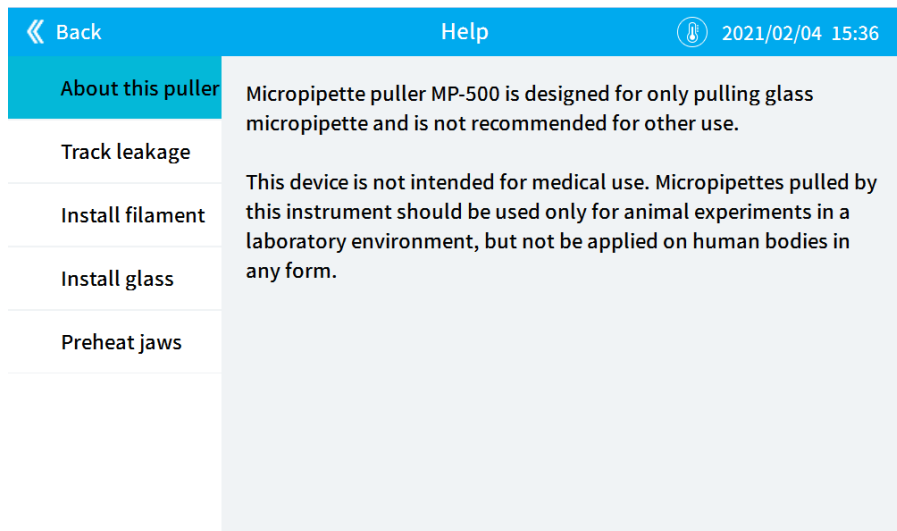

Figure 4-23

### 2) Track leakage

Click and operate following the prompts to locate leakages, referring to **4.12.1 System diagnosis**.

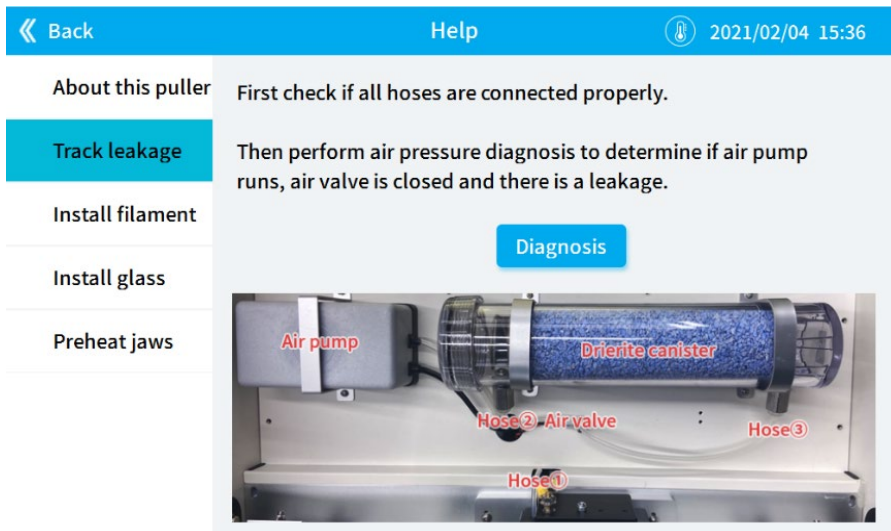

Figure 4-24

### 3) Install filament

Users can check the installation method of heating filaments step by step, or refer to **6.3 Replace filament**.

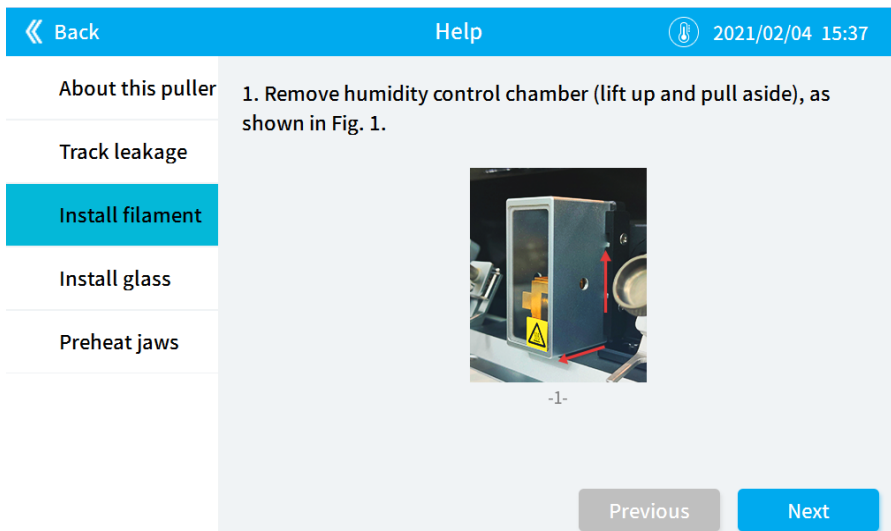

Figure 4-25

### 4) Install glass

Users can check the installation method of glass step by step, or refer to **4.2 Install glass**.

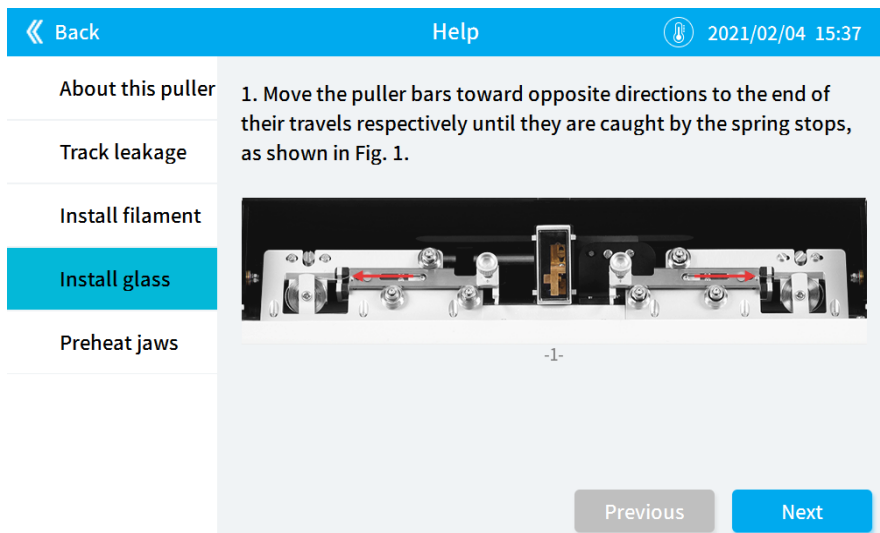

Figure 4-26

5) Preheat jaws

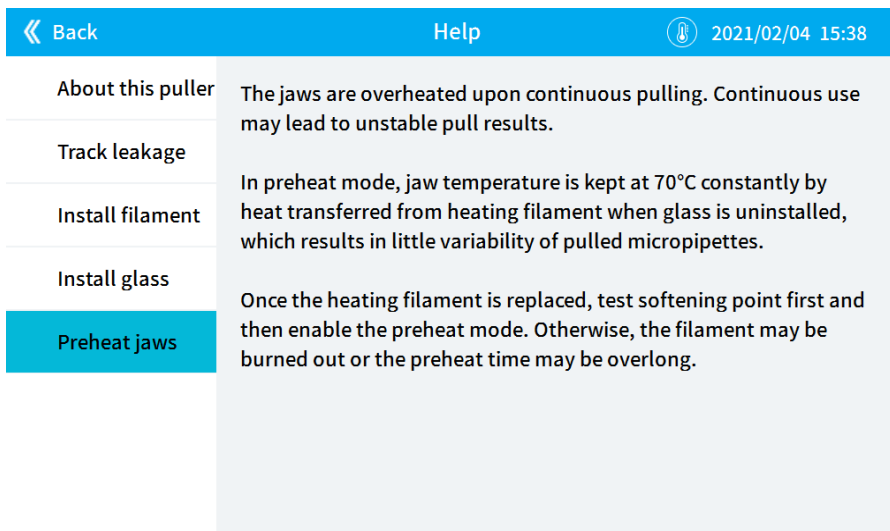



Figure 4-27

### 4.12.3 System Maintenance

Click  to decrease the brightness and click  to increase the brightness.

[Maintenance] is only for RWD after-sales personnel.

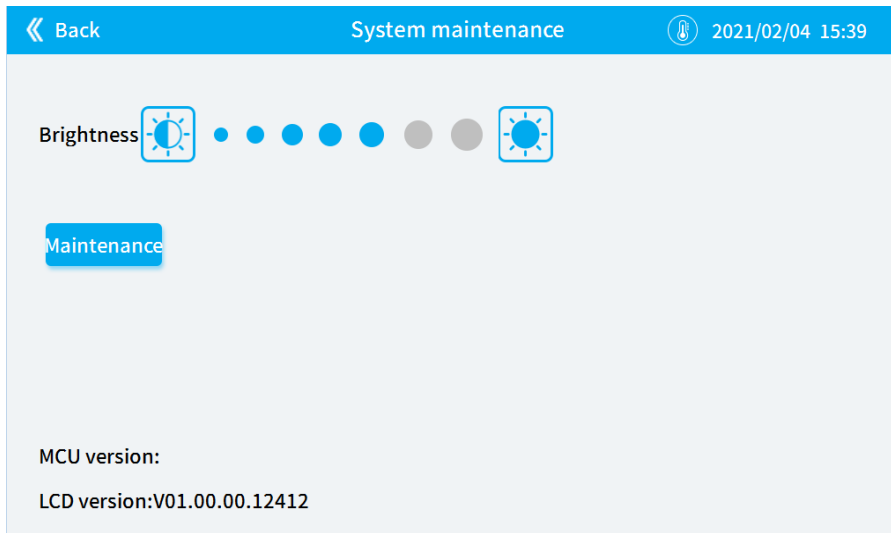

Figure 4-28



## 5-Troubleshooting

Alarms/Faults	Solutions
<p>Electric circuit overheated. Wait for cooling down to 70°C. Please contact technical support if the problem persists after sufficient cooling.</p>	<ol style="list-style-type: none"> <li>1) Wait for the system to be cooled down to 70 °C;</li> <li>2) If the alarm is not removed, Please contact our after-sales personnel</li> </ol>
<p>Stop using puller. Wait for jaw to be cooled down to 90°C</p>	<ol style="list-style-type: none"> <li>1) Wait for the jaw to be cooled down to 90 °C;</li> <li>2) If the alarm is not removed, please contact our after-sales personnel</li> </ol>
<p>Low air pressure. May be due to air leakage or other problems. Go to [System Diagnosis] to explore. Please contact technical support if problem persists.</p>	<ol style="list-style-type: none"> <li>1) Enter [System Diagnosis] interface;</li> <li>2) If the alarm is not removed, please contact our after-sales personnel</li> </ol>
<p>Heating electric circuit abnormal. Please confirm the heating filament has been installed and not been burned out, and the temperature sensor works properly, then restart. Or go to [System Diagnosis] to determine heat value. Please contact technical support if this problem cannot be solved.</p>	<ol style="list-style-type: none"> <li>1) Restart or enter [System Diagnosis] interface;</li> <li>2) Replace a new filament;</li> <li>3) If the alarm is not removed, please contact our after-sales personnel</li> </ol>
<p>Failed to melt capillary glass. Heating filament may be damaged or the Heat value may be too low (please test Softening Point and turn on Safe Heat mode)</p>	<ol style="list-style-type: none"> <li>1) Perform Softening Point test and turn on Safe Heat mode;</li> <li>2) Replace a new filament;</li> <li>3) If the alarm is not removed, please contact our after-sales personnel</li> </ol>
<p>Softening point is 0. Unable to check Heat. Please set softening point or turn off safe heat mode (not recommended).</p>	<p>Set softening point or turn off safe heat mode</p>
<p>Heat value should be in range of min-max, or turn off safe heat mode (not recommended).</p>	<ol style="list-style-type: none"> <li>1) Reset softening point or turn off safe heat mode;</li> <li>2) If the alarm is not removed, please contact our after-sales personnel</li> </ol>
<p>Jaw preheat time overlong. Softening point value may be improper or heating assembly may have been damaged. “Preheat jaws to 70°C” has been disable.</p>	<ol style="list-style-type: none"> <li>1) Reset the softening point value;</li> <li>2) Replace a new filament;</li> <li>3) If the alarm is not removed, please contact our after-sales personnel</li> </ol>

# 6-Maintenance

## 6.1 Overview

---

This chapter describes how to maintain the Micropipette Puller to ensure that it is in good working condition.

## 6.2 Cleaning and Maintenance

---

- The device should be placed on a level and stable platform to avoid vibration;
- Please do not knock hard or touch the screen with something sharp;
- Wipe the surface of the device with dry cloth, wipe the touch screen with lens paper, and do not wipe the surface of the device or the touch screen with chemical reagents. Do not touch the heating filament during cleaning;
- Use dry cotton swabs to clean the pulleys and V-groove regularly to avoid dust accumulation;
- Use a dry cotton swab or brush to clean the glass residue on the operating table;
- Try to prevent vibration or collision when the device is moved;
- When the accessories of the device are damaged, please contact RWD after-sales service for inspection and maintenance. The device shall not be disassembled by unauthorized personnel to avoid injury to the operator or damage to the device.



### Note!

The pulley assembly of this device should not be lubricated to avoid polluting the microelectrode.

## 6.3 Replace filament

---

1) Before replacing the heating filament, turn off the power switch and wait for the jaw temperature to decrease to normal to prevent burns.



### Warning!

Before replacing the filament, be sure to turn off the power switch to avoid the risk of electric shock!

2) Remove humidity control chamber (lift up and pull aside), as shown in Figure 6-1.



Figure 6-1

3) Unscrew the two screws on the jaw, as shown in Figure 6-2, and remove the old heating filament.



Figure 6-2

4) First check whether the jaw groove corresponds to the size of the new filament, as shown in Figure 6-3. If the size corresponds, install the new filament directly on the jaw. If the size does not correspond, unscrew the screw ① on the jaw and remove the jaw ②, as shown in Figure 6-4.

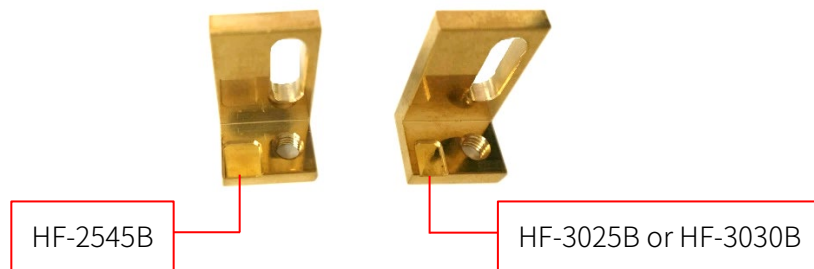

Figure 6-3

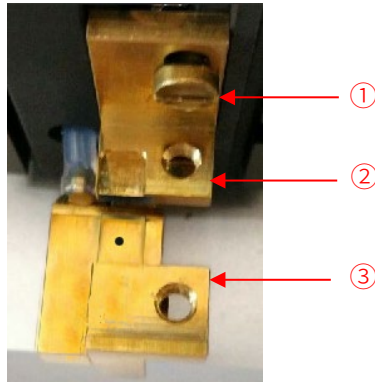

Figure 6-4

- 5) Replace the jaw ② corresponding to the size of the new filament, and tighten the screw ①. Note that the jaw groove ② should be flush with the jaw ③, as shown in Figure 6-4.
- 6) Clamp capillary glass in the right puller bar, and make left end of the glass in the middle between two brass jaws, as shown in Figure 6-5.

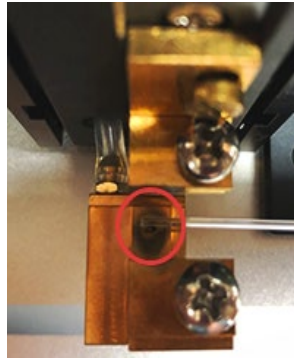

Figure 6-5

- 7) Install the new heating filament on the jaw to make the glass go through the center of the filament, and put in two screws ①②. Be careful not to tighten the screws at this time, as shown in Figure 6-6.

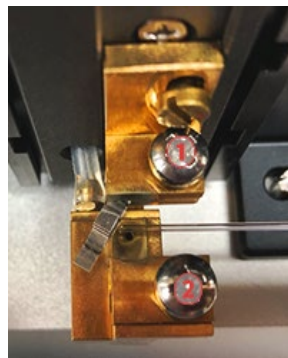

Figure 6-6

 **Note!**

To prevent potential damage, do not pinch the filament or touch it with sharp objects such as tweezers tip.

8) Slide the glass to the left edge of the filament and extend out as much as possible. Hold the left end of the glass and gently swing it back and forth to finely position the filament centered over air jet opening and around the glass, as shown in Figure 6-7.

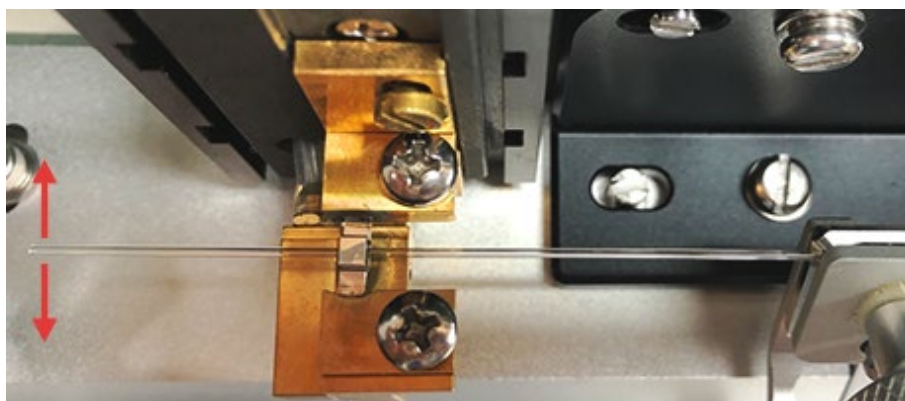

Figure 6-7

9) After the filament is centered to proper position, tighten the screws ① and ②, as shown in Figure 6-8.



Figure 6-8

10) Hold the jaw, loosen screws ① and ②, and adjust both jaws up and down as shown in Figure 6-9, until the glass is vertically centered inside the filament.



When loosening screws ① and ②, hold this jaw to prevent the filament from damage!

Figure 6-9

11) If the glass is not vertically centered, loosen the screw ① and turn the screw ② to finely adjust vertically until the glass is centered in the filament, as shown in Figure 6-10.



Figure 6-10

12) If the glass is not horizontally centered, loosen the screw ① and turn the screw ② to finely adjust horizontally until the glass is centered in the filament, as shown in Figure 6-11. Finally, the relative positions of the heating filament, the glass, and the air jet opening are shown in Figure 6-12.

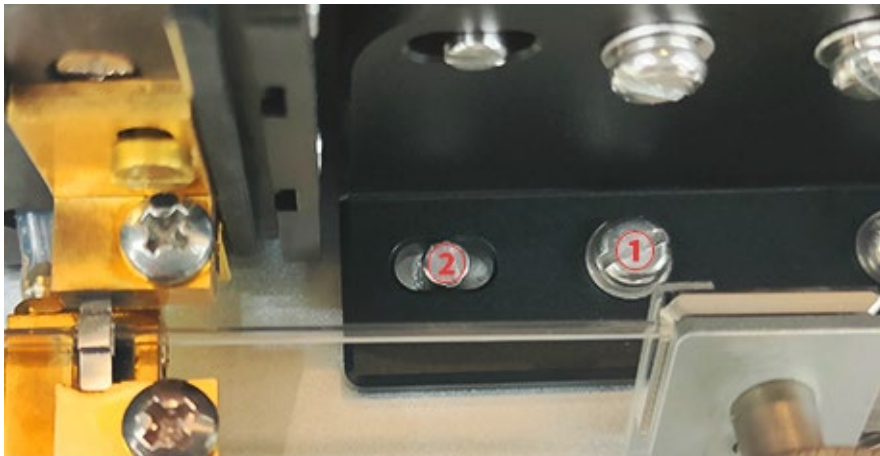

Figure 6-11

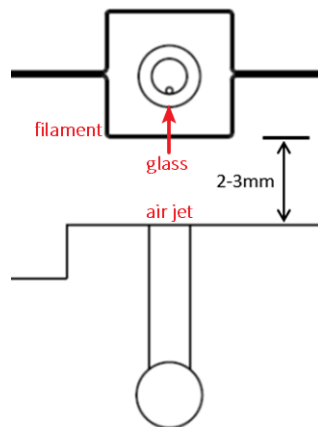

Figure 6-12

13) Turn on the power switch, pull the glass to verify the installation of the heating filament, and refer to 4.3 Softening point Test—4.9 Pull result.

 **Warning!**

Do make sure to adjust the filament and test the softening point after replacing a new heating filament!

14) Align the tips of the left and right micropipettes side by side and compare their lengths from tip to shoulder. If the left taper is longer, as shown in Figure 6-13, please loosen the screws ① and ②, and slightly move the filament as indicated by the arrow shown in Fig.6-14.

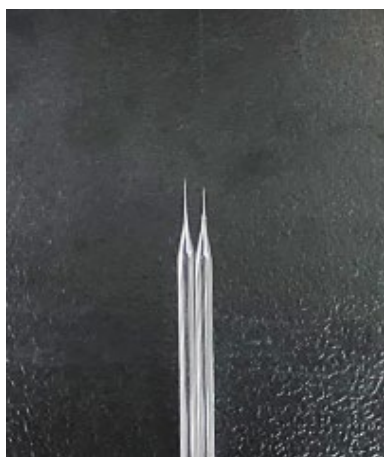

Figure 6-13

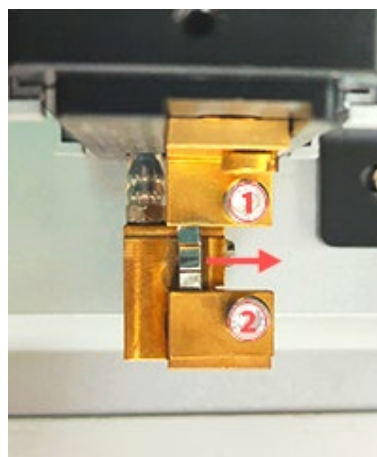

Figure 6-14

15) If the left tips are shorter than the right one, please loosen the screws ① and ②, and slightly move the filament as indicated by the arrow shown in Fig. 6-16. A pair of symmetric tips means that the filament has been installed successfully, as shown in Figure 6-17.



Figure 6-15

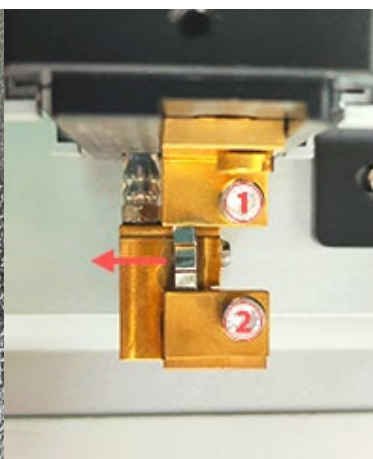

Figure 6-16

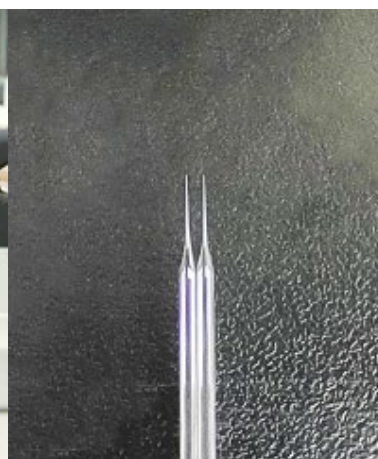

Figure 6-17

## 6.4 Replace Drierite canister

---

When the drierite is dry, it is blue or blue-purple, and becomes pink after absorbing moisture. When two thirds of the drierite is pink, replace it with a new drierite canister.

- 1) Unplug the power wire before replacing the drierite canister.

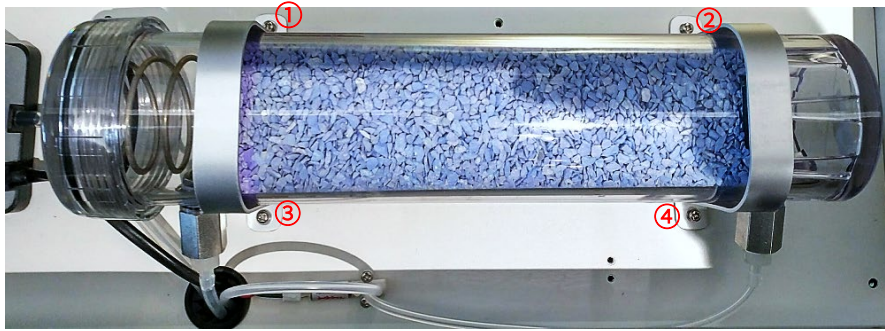

Figure 6-18

- 2) Remove the left and right hoses from the drierite canister.
- 3) Remove the fixing screws①, ②, ③, ④.
- 4) Replace with a new drierite canister.
- 5) Tighten the fixing screws①, ②, ③, ④.
- 6) Connect the left hose, enter the [Pressure diagnosis] interface as shown in Figure 6-19, set [Set pressure] to 999, turn on [Automatic pressure] and [Air valve], turn on the air pump and spray for a few minutes to remove the dust in the canister.

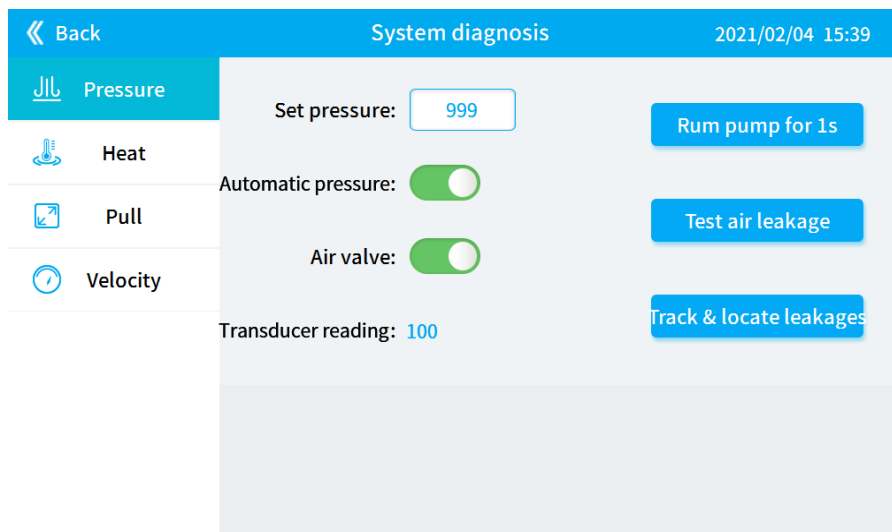

Figure 6-19

 **Note!**

Do not connect the hose on the right side at this time, so as to prevent dust from blowing in and block the air valve.

- 7) Connect the right hose and reconnect the power.



Drierite can be reused after drying. The specific drying method is as follows:

- 1) Pour the drierite into a heat-resistant container and spread it out as far as possible.
- 2) Put the drierite in the oven and dry it at 200 °C for one hour. Observe whether the drierite turns blue. If not, increase the drying time until it turns blue.
- 3) After drying, transfer the drierite to the glass container before the drierite temperature drops.
- 4) Cool the drierite and then put it back in the canister.

## 6.5 General check

---

- Please confirm that the filament has been installed and is not damaged;

Please check the shape of the filament before installing. The normal shape of the filament is shown in Figure 6-20 (right). The deformed heating filament cannot be used. Use tweezers and other tools to restore the heating filament to its normal shape before use.



Figure 6-20

- After replacing the filament, be sure to adjust the new one. Please refer to **6.3 Replace filament**;
- Confirm whether the touch screen operation is normal;
- Confirm whether the identification is firmly pasted;
- If it is found that some parts or materials need to be replaced during general check or maintenance, please contact RWD after-sales service for support.

## 6.6 Annual inspection

---

RWD recommends a comprehensive inspection of the device on a yearly basis, which is helpful to keep the device in good operating condition. For details, please contact RWD. It is recommended to record the maintenance process, including the maintenance time, location, and process for future reference.

## 7-Warranty

The warranty for this system starts from the day when it leaves the factory. RWD provides after-sales support such as device maintenance and parts replacement in case of the device failure due to defects in materials or process during the warranty period.

Any device damage caused by incorrect use or out-of-range use is out of the scope of the warranty, and in case of any need for repairs or parts replacement, the costs incurred should be borne by the user.

If it is found that the device returned for repair is found to have been disassembled without authorization of RWD upon arrival, RWD will not provide after-sales services such as quality warranty, free maintenance and parts replacement.

The warranty statement (including its limitations) is issued exclusively by RWD and covers all other warranty conditions.



## RWD Life Science Co., Ltd.

Web: [www.rwdstco.com](http://www.rwdstco.com)

Add: 850 New Burton Road, Suite 201, Dover, DE 19904, Kent, Delaware, USA

Add: 19/20F, Building 9A, Vanke Cloud City III, Liuxin 4 Street, Nanshan District, Shenzhen 518000,  
Guangdong, P.R. China

Tel: +001-858-900-6602 +86-755-86111286

After-sales Service: +86-755-86111281

After-sales E-mail: [service@rwdstco.com](mailto:service@rwdstco.com)